

V	B	KW
120		.75
240		3
208		2.3

DO NOT USE ON 480 V

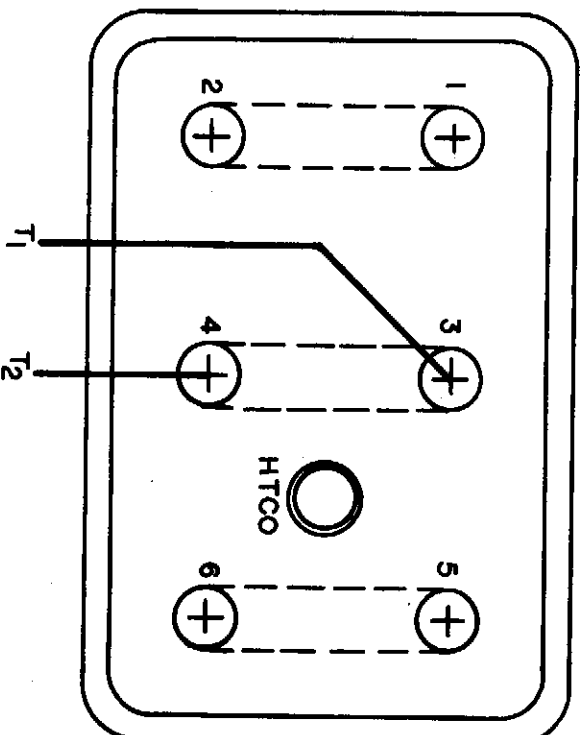
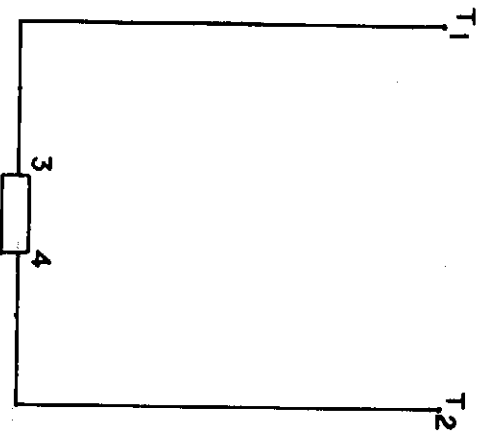

B 120/240 V, 1  $\phi$ , 60 HZ

JOB #



CRYOGENIC  
EXPERTS INC

TITLE: BUSSING DIAGRAM  
MINIATURE VAPORIZER HEATER

DWG

SHT

V	B	KW
120		1.5
240		6
208		4.5

DO NOT USE ON 480 V

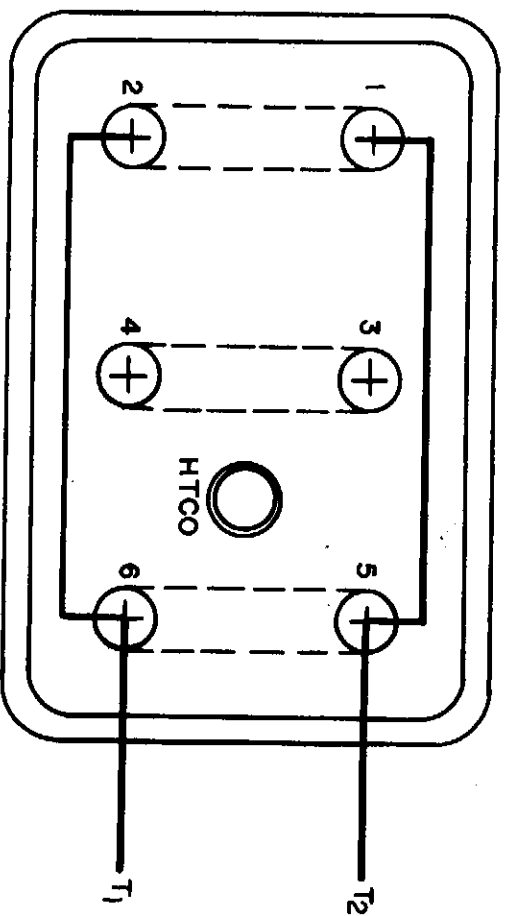
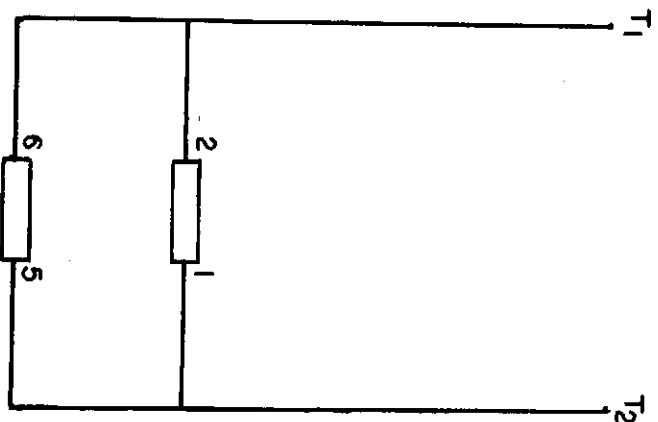

B 120/240 V, 1  $\phi$ , 60 HZ

JOB #

**EXI** CRYOGENIC EXPERTS INC

TITLE: BUSSING DIAGRAM  
MINIATURE VAPORIZER HEATER

DWG.

SHT

V	B	KW
120	2.25	
240	9	
208	6.8	

DO NOT USE ON 480 V

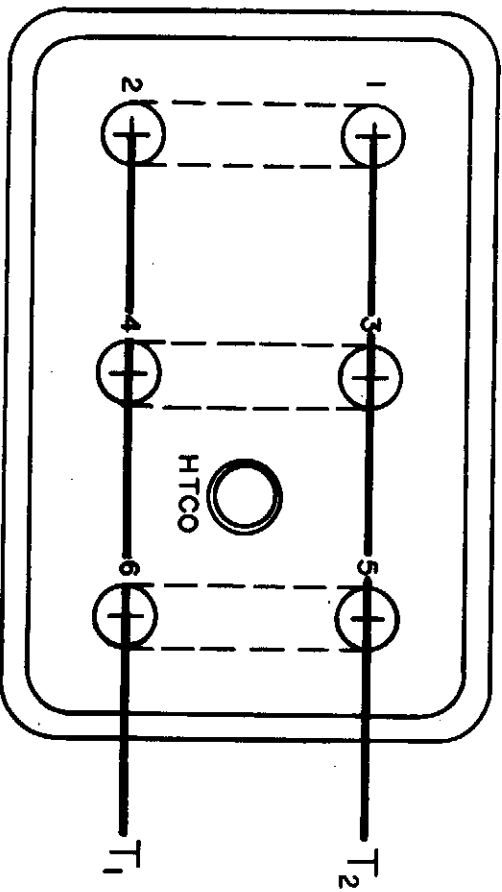
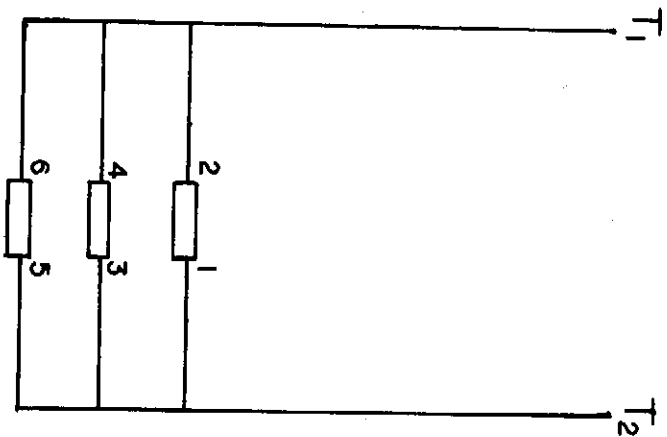

B 120/240 V, 1  $\phi$ , 60 HZ

JOB#

DWG.

SHT



CRYOGENIC EXPERTS INC

TITLE: BUSSING DIAGRAM  
MINIATURE VAPORIZER HEATER

V	B	KW
208		
240	1.5	
480	6	

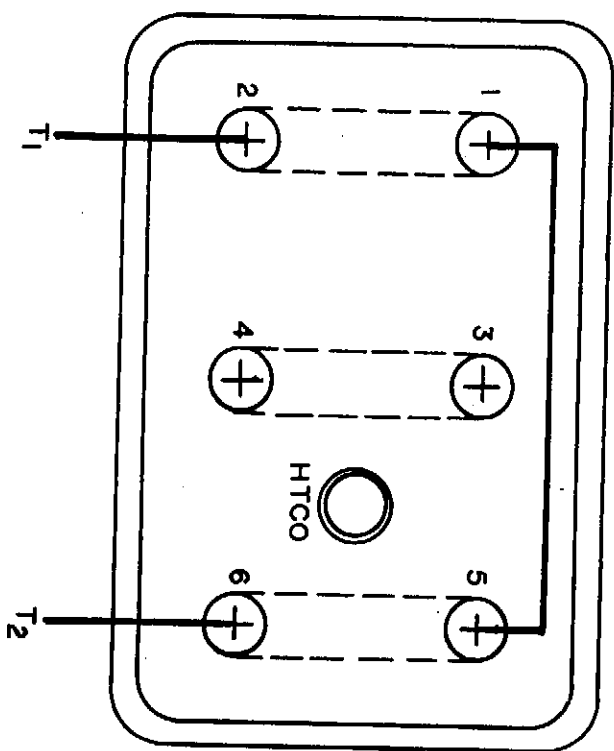
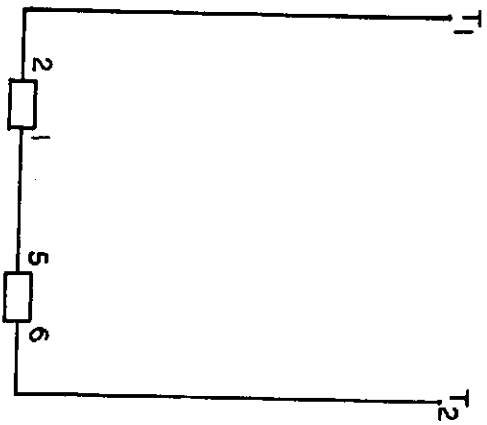

B 240/480 V, 1  $\phi$ , 60 HZ

JOB #



CRYOGENIC EXPERTS INC

TITLE: BUSSING DIAGRAM  
MINIATURE VAPORIZER HEATER

DWG.

SHT

V	B	KW
480		4

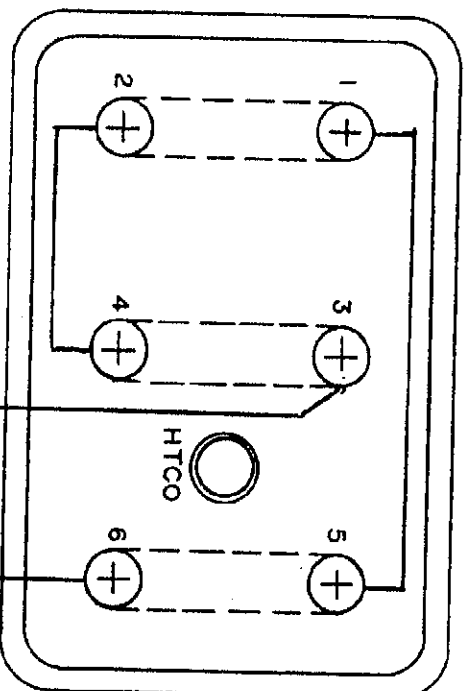
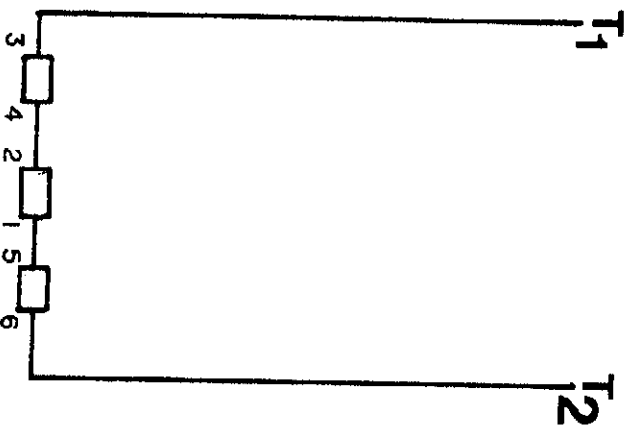

480 V, 1  $\phi$ , 60 HZ



CRYOGENIC  
EXPERTS INC

TITLE: BUSSING DIAGRAM  
MINIATURE VAPORIZER HEATER

DWG.

SHT

V	B	KW
120		1.13
240		4.5

DO NOT USE ON 480 V

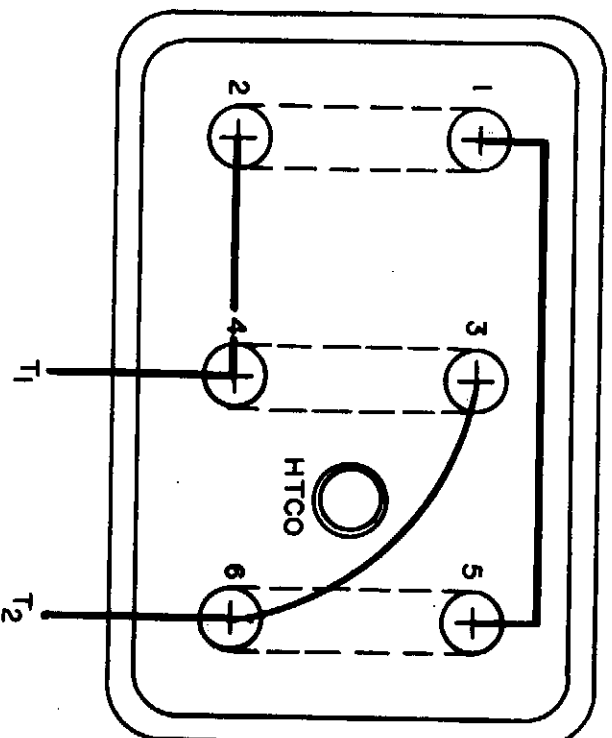
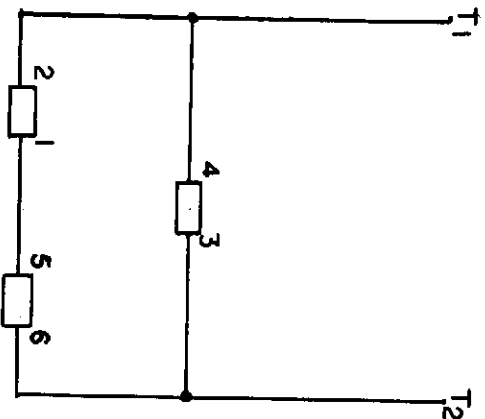

B 120/240 V, 1  $\phi$ , 60 HZ



CRYOGENIC  
EXPERTS INC

TITLE: BUSSING DIAGRAM  
MINIATURE VAPORIZER HEATER

JOB #

DWG.

SHT

V	B	KW
240		9
208		6.8

DO NOT USE ON 480 V

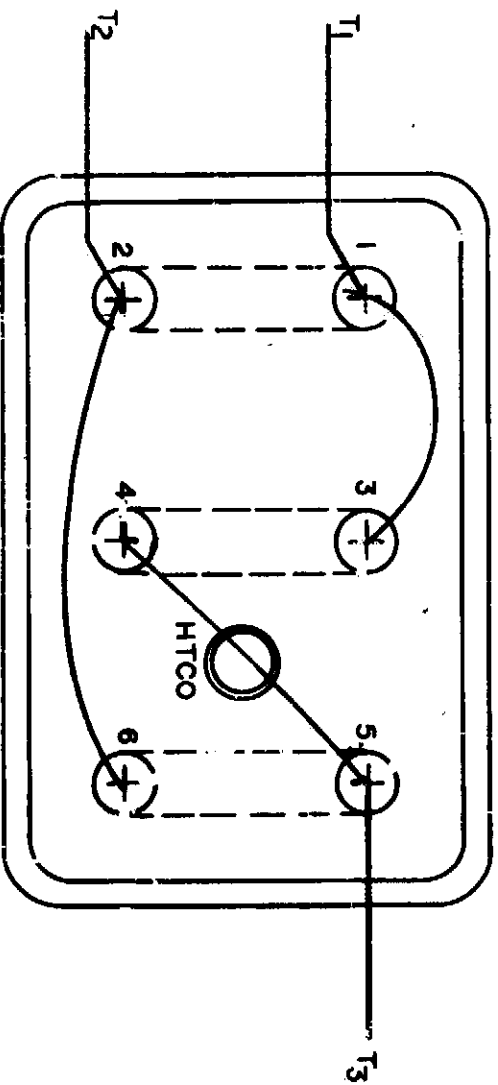
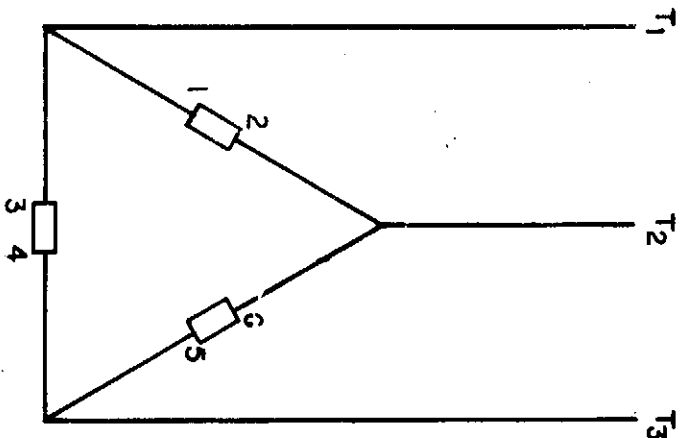

B 208/240 V, 3  $\phi$ , 60 HZ



CRYOGENIC EXPERTS INC

TITLE: BUSSING DIAGRAM  
MINIATURE VAPORIZER HEATER

JOB #

DWG.

SHT

V	B	KW
260	12	
240	3	
480	12	
380	7.5	

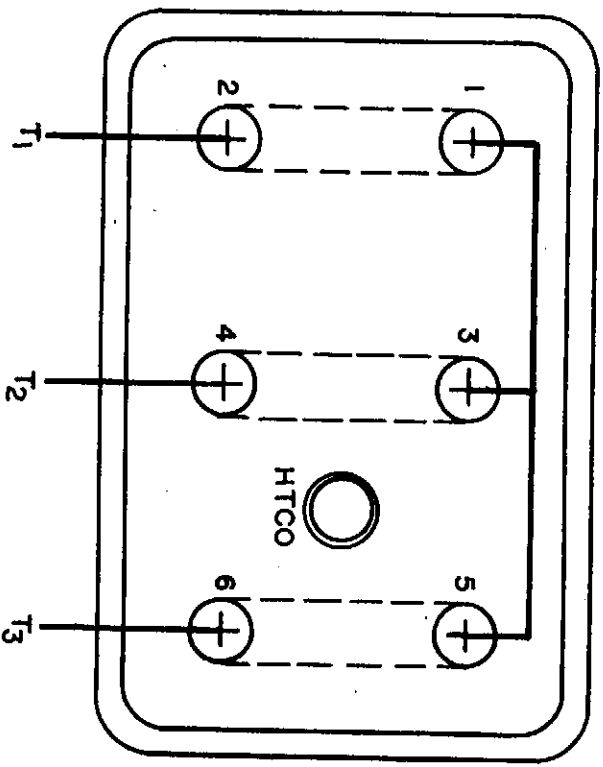
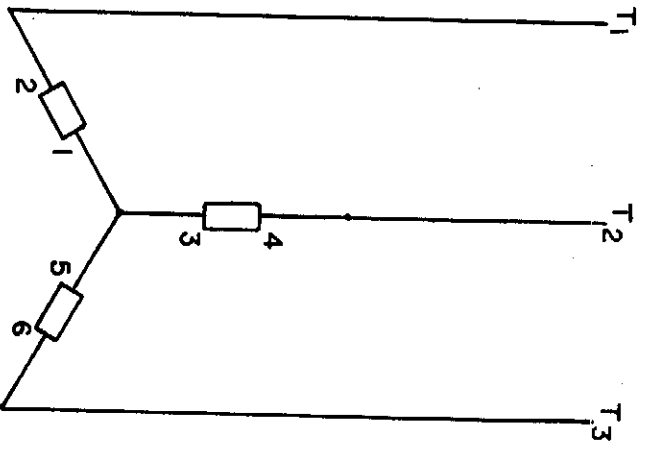

B 240/480 V, 3  $\phi$ , 60 HZ

JOB#



CRYOGENIC EXPERTS INC

TITLE: BUSSING DIAGRAM  
MINIATURE VAPORIZER HEATER

DWG

SHT